



WeOxy Portable Oxygen Concentrator

Quick Start Guide

Welcome: Thank you for choosing the WeOxy Portable Oxygen Concentrator! This guide helps you get started quickly and safely.

Important: Read the full user manual for detailed information before use.

Safety Notice: Always use WeOxy with prescribed settings. Keep away from heat, flames, and water. Do not block airflow or use incompatible accessories.



Please confirm that your WeOxy Portable Oxygen Concentrator system includes the following components:

Included Items

- **Portable Oxygen Concentrator**
- **One Pre-installed Battery**
- **AC Power Adapter & Power Cord Type-C 100W**
- **Carrying Bag & Shoulder Strap & Backpack Straps & Hip Belt**
- **User Manual & Quick Start Guide**
- **Nasal Cannula**



Presentation instructions

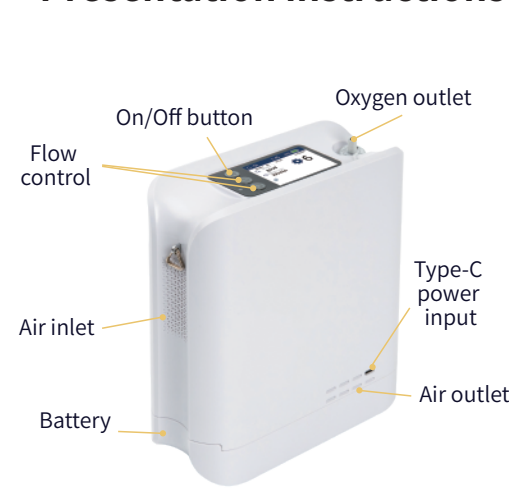

Battery level indicator

Press the button on the battery to check the remaining charge. Indicator lights will show the battery level.

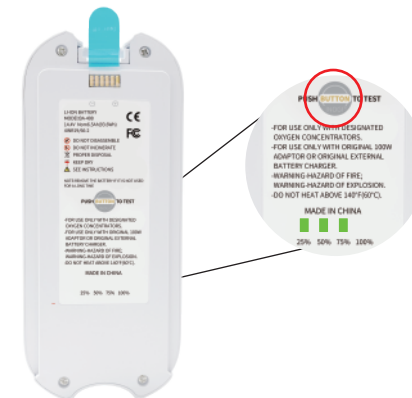

Optional external battery charger kit



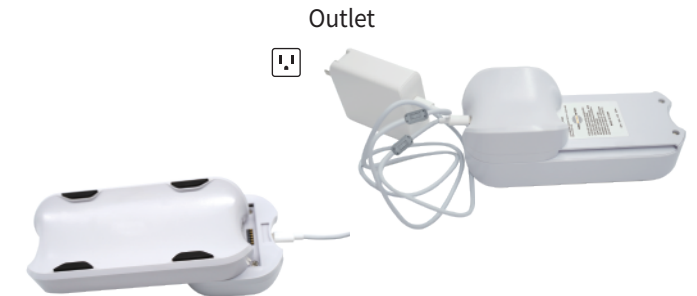

(Part No: UR1-12-02)





For faster charging, use the **External battery charger**. Place the battery on the dock and connect to power.



Additional batteries and the external charger are available for purchase. Contact your provider.

Using your concentrator

Step	Description	
1	Remove the device from the carrying bag and place it in a well-ventilated area.	
2	(For first-time use): Remove the battery from the device, peel off the insulation sticker, and reinsert the battery.	
3	Connect your concentrator to AC power. Plug the AC cord into the concentrator.	
4	Press and hold the power button for 2 seconds to turn on the concentrator. You will hear one short beep, and the indicator light will flash. The device will enter a 5-second self-check, followed by a 2-minute warm-up.	

Step	Description	
4	Do NOT use the device during the self-check.	
5	Adjust the flow rate as prescribed by your healthcare provider using the "+" and "-" buttons.	
6	Attach the nasal cannula to the oxygen outlet. Position your nasal cannula on your face and breathe normally through your nose. A green light will flash each time a breath is detected.	
7	TO TURN OFF: Press and hold the power button for 3 seconds.	

Battery operating duration

Device setting	High-performance battery duration in hours(BA-408)	Power battery duration in hours(BA-704)
1	Up to 6:50	Up to 8:00
2	Up to 5:00	Up to 5:35
3	Up to 3:00	Up to 3:25
4	Up to 2:00	Up to 2:20
5	Up to 1:40	Up to 2:00
6	Up to 1:25	Up to 1:35
S	Up to 1:10	Up to 1:25

* ±5%(0 ft, 25°C/77°F, fully charged)

Make sure you have a backup oxygen supply in addition to this portable concentrator.

Battery replacement

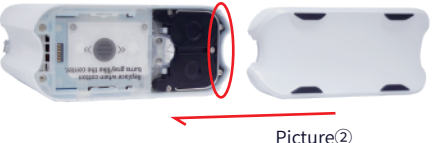
Step	Description	
1	To remove the battery: Press the buckle as shown in the red circle in picture ①, and slide the battery out in the direction indicated by the arrow in the picture.	 Picture①
2	Remove the insulating tape on the battery surface. Make sure that the insulating tape is removed before using the device, otherwise the device cannot be powered on. To install the battery: Align the battery with the slot and slide it into the device in the direction indicated by the arrow in picture ②.	 Picture②

Instruction for using the strap

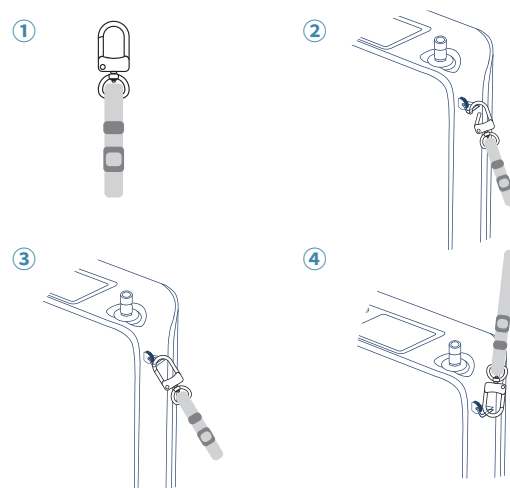



Carry bag options

Your WeOxy portable oxygen concentrator offers three carrying options:

- ◆ **Shoulder strap**
- ◆ **Backpack Straps**
- ◆ **Hip Belt**

Choose the option or combination that best suits your needs.

Options	Description	
1	Shoulder strap	
2	Backpack Straps	
3	Belt	